

USG BILLO™ 3-DIMENSIONAL PANELS



USG Billo™ 3-Dimensional Panels,
White Opaque/USG Donn® Brand
Centricitee™ DX™ Acoustical
Suspension System, Flat White

TO ORDER SAMPLES, GO TO USG.COM OR CGCINC.COM

WHITES

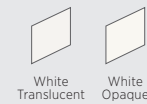

COLOR GALLERY



FEATURES AND BENEFITS

- Three-dimensional curved panels punctuate flat ceiling planes with rhythm and depth.
- 2'x2' preformed polycarbonate panels create myriad patterns with just one simple panel shape.
- Lightweight lay-in panels install into 9/16" narrow-profile USG Donn® Brand suspension systems, allowing full ceiling accessibility.
- Luminous panels may be backlit with fluorescent strip fixtures or integrated with standard lay-in fixtures.

APPLICATIONS

- Interior Applications
- Wall to Wall Ceilings
- New Construction or Renovation
- Patterned aesthetics

Weave Pattern

Wave Pattern

USG BILLO™ 3-DIMENSIONAL PANELS

ORDER SAMPLES/LITERATURE
 USG: usg.com or samplitt@usg.com
 CGC: contact Sales Representative

TECHNICAL SERVICES
 800.USG.4YOU (874-4968)

FOR MOST UP-TO-DATE
 TECHNICAL INFORMATION
 AND LEED REPORT TOOL
usgdesignstudio.com
cgcdesignstudio.com

PRODUCT INFORMATION

Materials	Sizes and Weight	Module Size
Panels: Preformed polycarbonate. Suspension System: All 2'x2' USG Donn® Brand 9/16" Centricitee™ DXT™, Identitee® DXI™, and Fineline® DXF™/DXFF™ profiles.	Panels: 2'x2' Weight: 0.25 lb./sq. ft.	Full 2'x2' modules only

FINISHES

Panel Color	Panel Light Transmission	Suspension System Coordinating Colors
White Translucent	26%	Flat White
White Opaque	8%	Flat White
Color Gallery Colors	Varies per Color	Flat White or per Specification

EDGE DETAILS

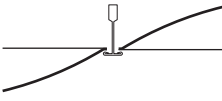
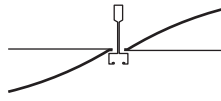
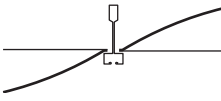
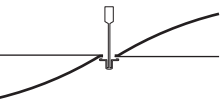
USG Billo™ Panels with 9/16" USG Donn® Brand Centricitee™ DXT™ Suspension	USG Billo™ Panels with 9/16" USG Donn® Brand Fineline® DXF™ Suspension	USG Billo™ Panels with 9/16" USG Donn® Brand Fineline® 1/8 DXFF™ Suspension	USG Billo™ Panels with 9/16" USG Identitee® DXI™ Suspension
			

PANEL HOLD-DOWN CLIP

Supplied with 9/16" down panels

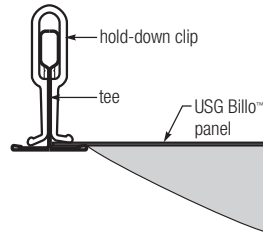

ASSEMBLY

View from above

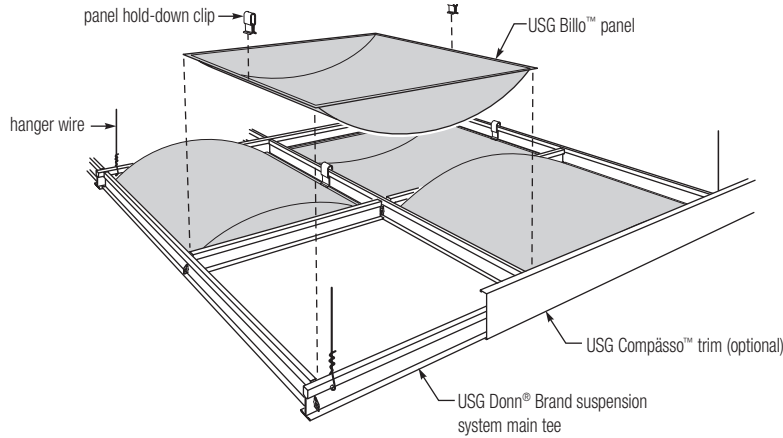

PHYSICAL DATA

Product literature

System brochure: IC472
 Data sheet: IC473
 Warranty: SC2102
 Installation: IC456
 Care and Maintenance: IC456

Online tools

usgdesignstudio.com or cgcdesignstudio.com

Fire rating

USG Billo™ panels meet the Class A acceptance criteria of 2021 IBC Section 803.1.1.1 for interior finishes as tested in accordance with NFPA 286.

USG Billo™ panels meet the Class B requirements for flame spread and smoke developed as tested in accordance with CAN/ULC S102 surface-burning characteristics.

Note

For Canadian product needs, please contact your local sales representative.

Ceiling layout design must be full ceiling panel module.

Notice

The information in this document is subject to change without notice. CGC Inc. or USG Corp. assumes no responsibility for any errors that may inadvertently appear in this document.

IC473/rev. 6-22

© 2022 USG Corporation and/or its affiliates. All rights reserved. Printed in U.S.A.

Manufactured by USG Interiors, LLC
 550 West Adams Street
 Chicago, IL 60661

The trademarks USG, CGC, BILLO, CENTRICITEE, COMPASSO, DONN, DXF, DXFF, DXI, DXT, FINELINE, IDENTITEE, IT'S YOUR WORLD, BUILD IT, the USG/CGC Logo, the design elements and colors, and related marks are trademarks of USG Corporation or its affiliates.

Safety First! Follow good safety/industrial hygiene practices during installation. Wear appropriate personal protective equipment. Read SDS and literature before specification and installation.

