

**USG CEILINGS PLUS<sup>®</sup>  
COLORTEX<sup>™</sup> BLADES**

ACOUSTIC PANEL SOLUTIONS

**INSTALLATION GUIDE**



# Introduction

Introducing **Colortex™ Blades** a new innovative ceiling design brought to you by **USG Ceilings Plus®**. In this manual we'll show you how to perform the installation for this rigid system the right way, the first time, and with confidence.

The purpose of this installation manual is to provide you with general steps on how to properly and safely install the **Colortex™ Blades** ceiling system.

Please read this entire manual and familiarize yourself with all procedures before you begin. If you have been supplied with project drawings specific to your order, make sure you have a thorough understanding of those. Any details within those documents will supersede this manual. Work area must be clear of debris and obstacles to ensure a safe and fast installation.

**Please work safely!**

---

# Table of Contents

## **Preparation**

Component Identification	1
Tools	2

## **General Installation**

Laser mark main tee locations on ceiling	3
Hanging of Main Tees	4
Dynamic Assembly Installation (Blades dash-1 thru dash-8)	5
Dynamic Assembly Installation (Blades dash-9 thru dash-16)	6
Static Assembly Installation	7
Blade Spacing	8
Multiple bay Assembly	9

## **Field Modification**

Adding a missing dynamic Blade	10
Adding Tee Face Sleeve Cover	11

## **Maintenance**

Adjust & Clean	12
----------------	----

## **Support**

Contacts	12
----------	----

## **Notices**

Safety, Installation, Limitation, Liability	13
---	----

## **Notes**

Planning	14
----------	----

# Preparation

## Component Identification

### Components

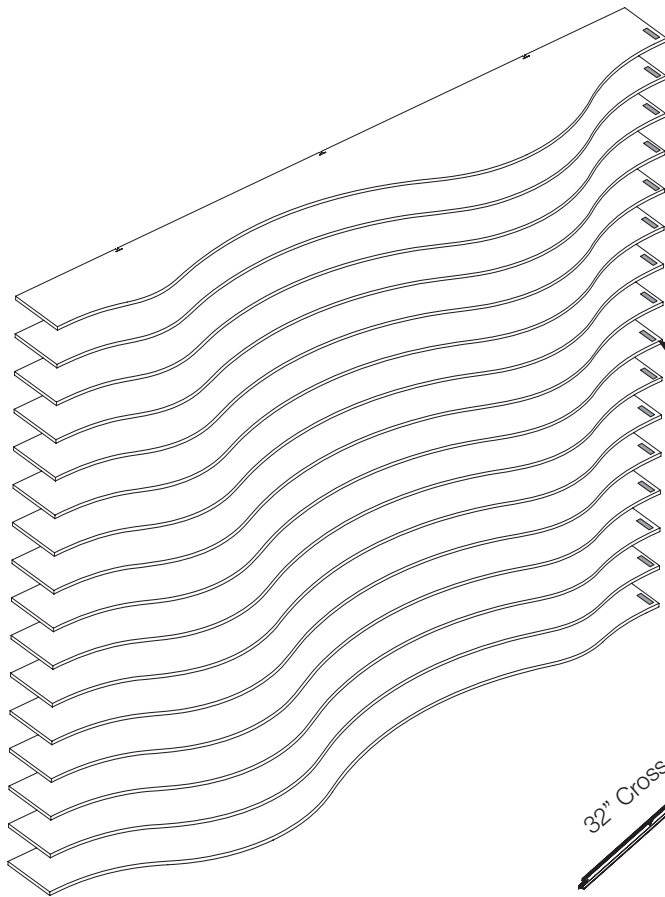

**Colortex™ Blades** comes with all components needed to build a complete assembly as shown.

Dynamic Blade assemblies have all blades individually numbered to facilitate assembly

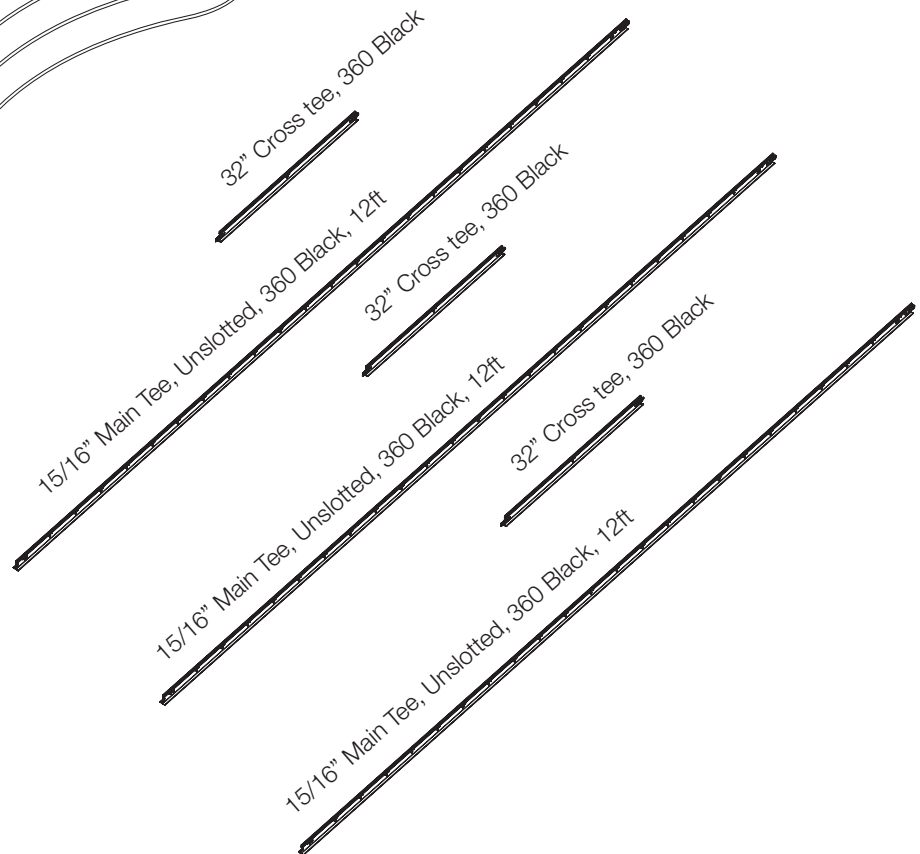

# Preparation Tools

## Standard Tools



Safety Goggles



Hard Hat



Tape Measure



Lineman Wire Cutters

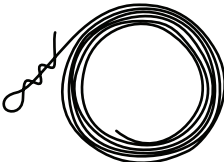

Hanger Wire

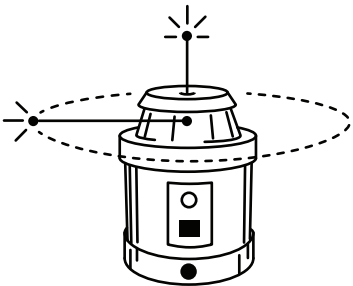

Laser Level

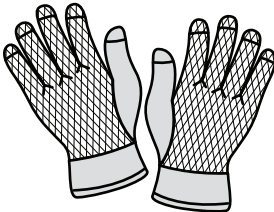

Working Gloves

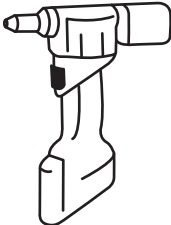

Metal Straight-Edge

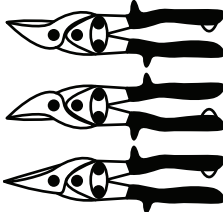

Shears

# General Installation

## Laser mark main tee locations on ceiling

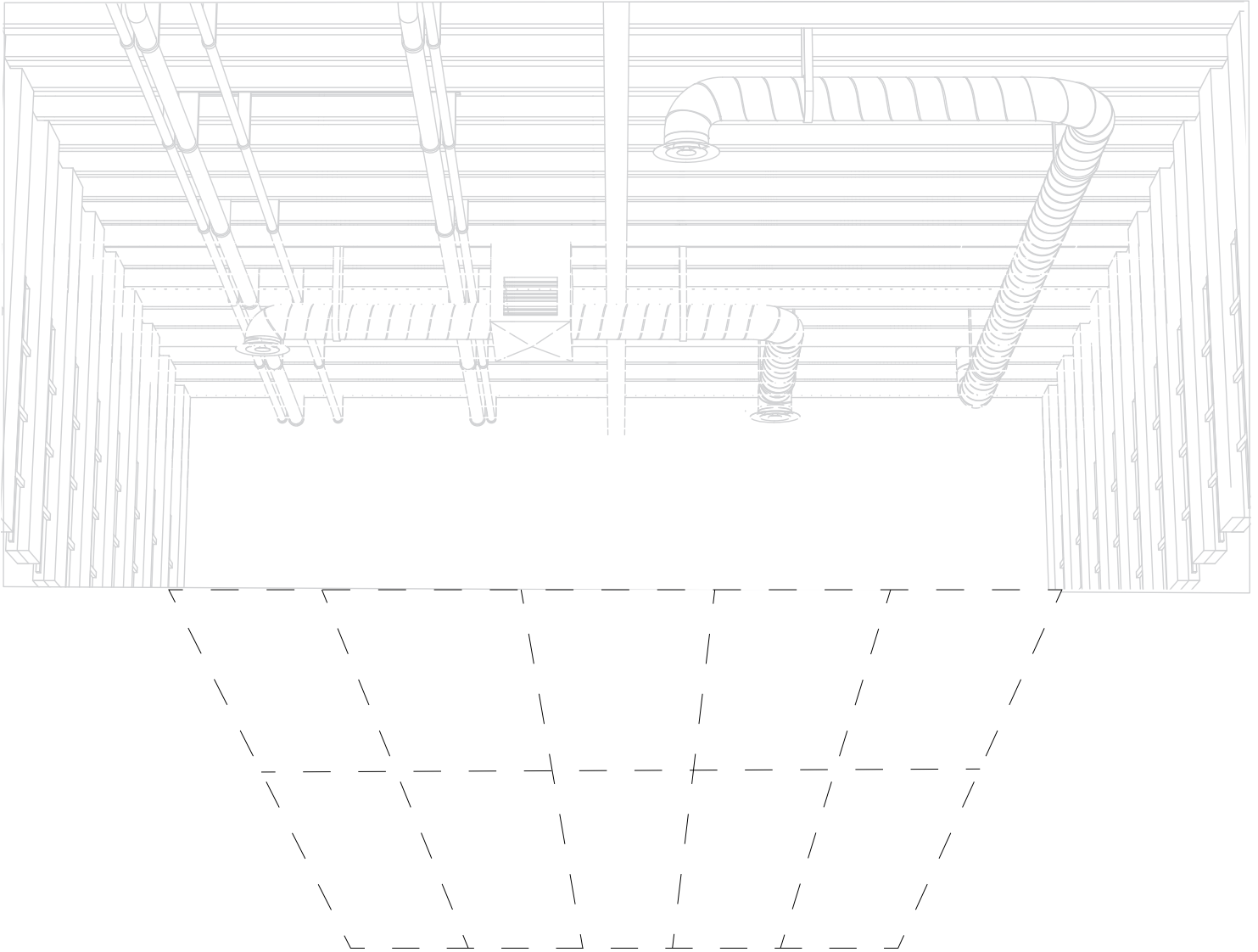

Use laser level to mark ceiling with the locations for the mounting of 15/16" Main tee's

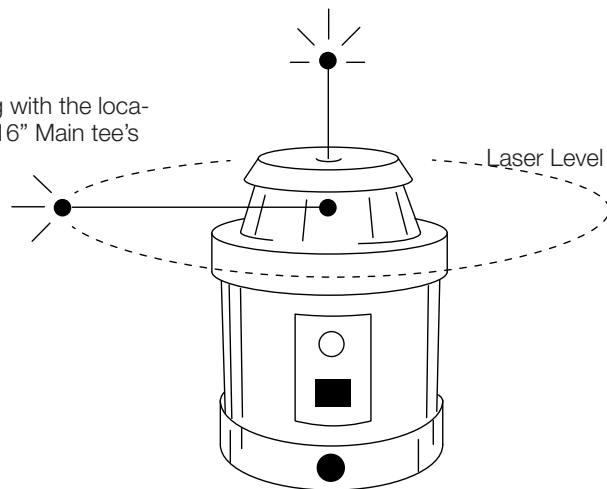

# General Installation

## Hanging of Main Tees

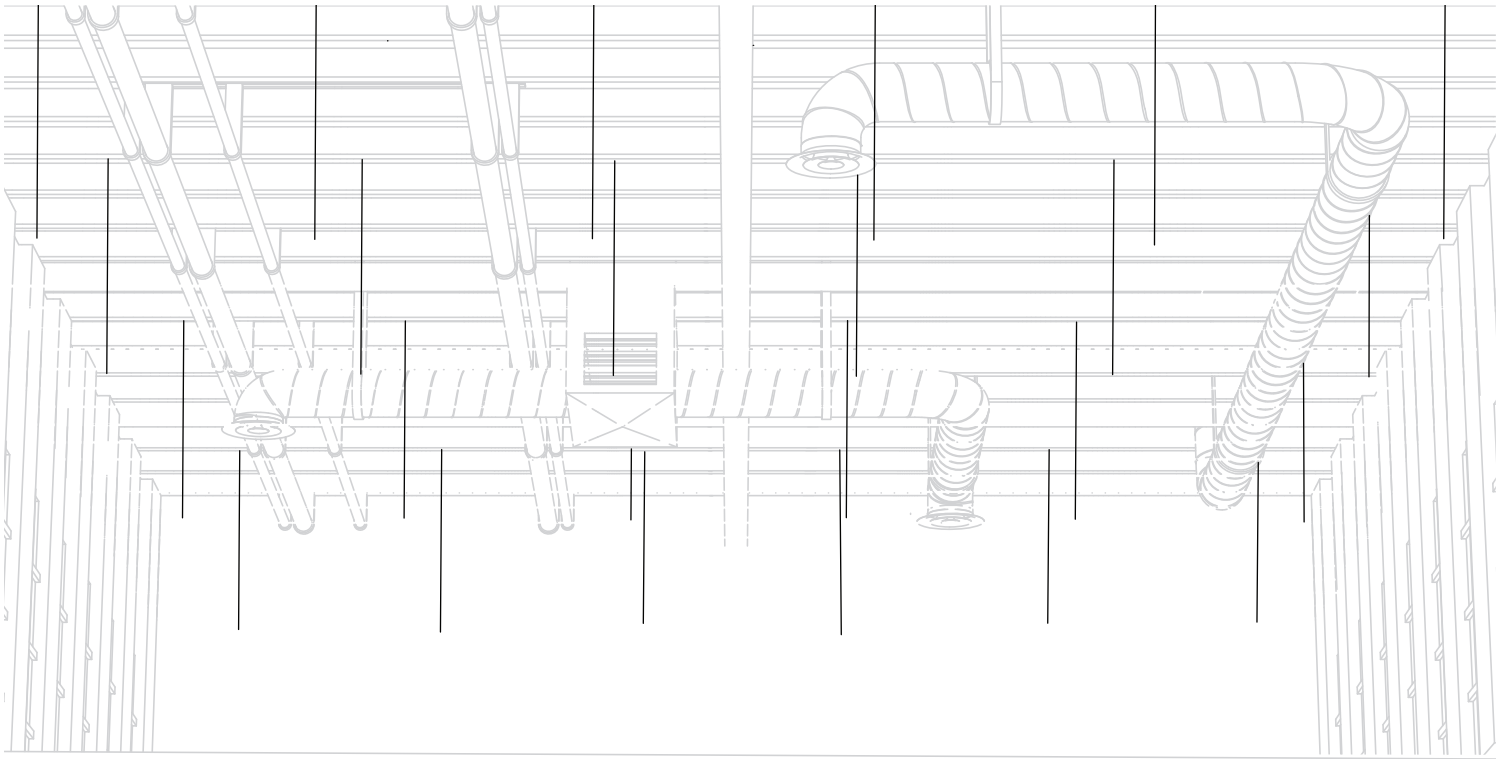

Dynamic Blade Assembly

**<- PREPARE ->**

Static Blade Assembly

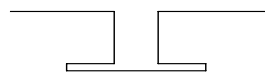
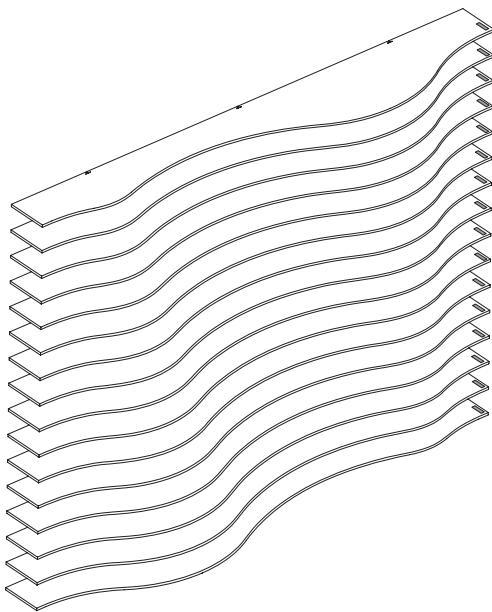

Slide Profile

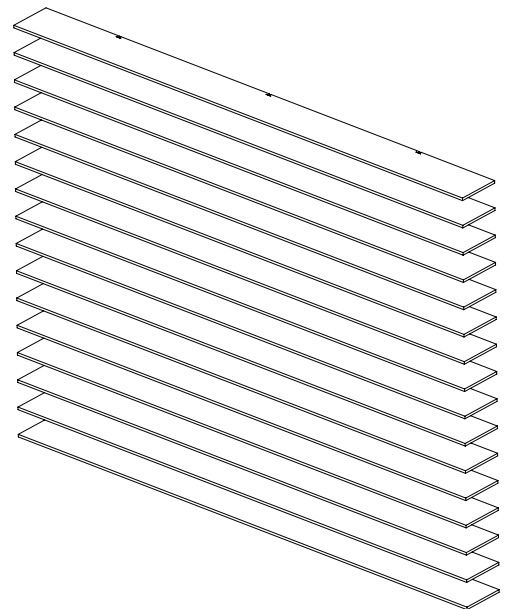

Unpack dynamic blades and ensure all blades are in numerical order (see labels on all blades) and uniform with their respective slide profiles.

Unpack static blades and simply orient them so all blades are uniform with their respective slide profiles..

# General Installation

## Dynamic Assembly Installation (Blades dash-1 thru dash-8)

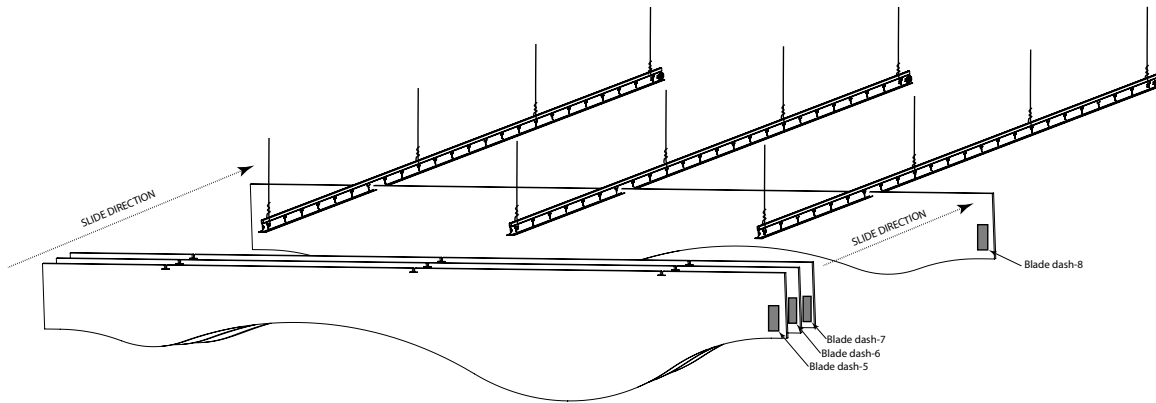

**Dynamic Assembly Blades dash-1 thru dash-8**

### **Suggested installation method for Dynamic Assembly (BLADES DASH -1 THRU DASH-8)** (one module consists of 16 blades)

- 1) Prior to sliding the blades on the Main Tee ensure they in numerical order (dash-1 thru dash-16).
- 2) Begin with blade dash-8, slide onto Main Tees and push blade dash-8 towards the middle of the Main Tee.
- 3) Continue with blade dash-7, then dash-6, dash-5....until you finish with blade dash-1.

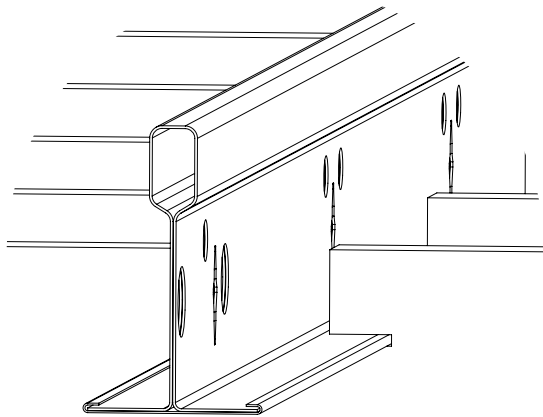

#### NOTE:

To facilitate sliding the blade on the Main Tee, ensure the blade is perpendicular to the Main Tee, not angled, as you begin to slide.

This will help push out any residual material from the Slide Profile of the Blade.

Additionally it will help maintain a proper fit and not distress the material unnecessarily.



# General Installation

## Dynamic Assembly Installation (Blades dash-9 thru dash-16)

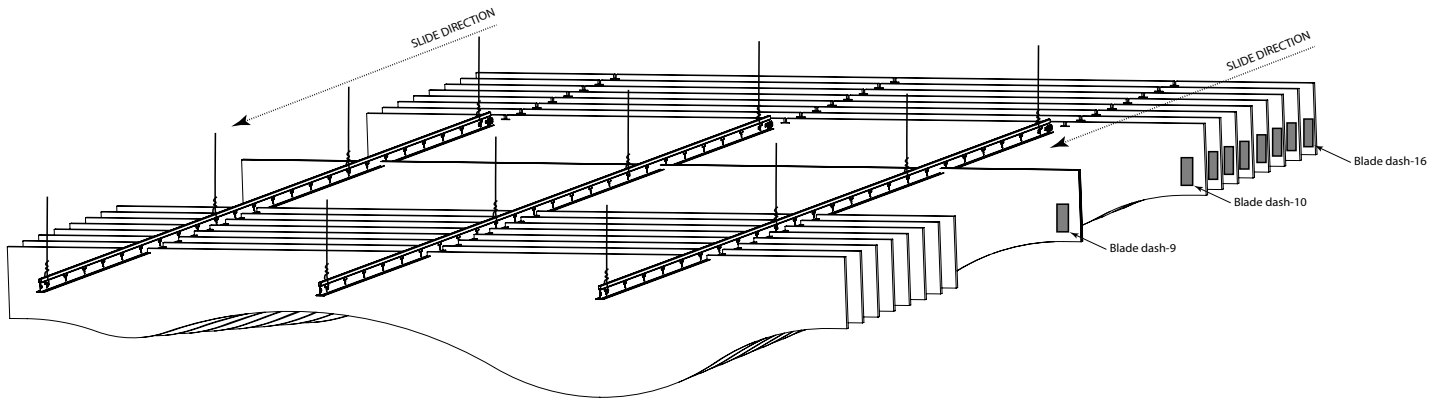

### Dynamic Assembly Blades dash-9 thru dash-16

#### Suggested installation method for Dynamic Assembly (BLADES DASH-9 THRU DASH-16) one module consists of 16 blades)

- 1) Move to the other end of the Main Tees and proceed with blade dash-9 and slide towards the blade dash-8 .
- 2) Proceed sliding the remaining blades dash-10 thru dash 16.

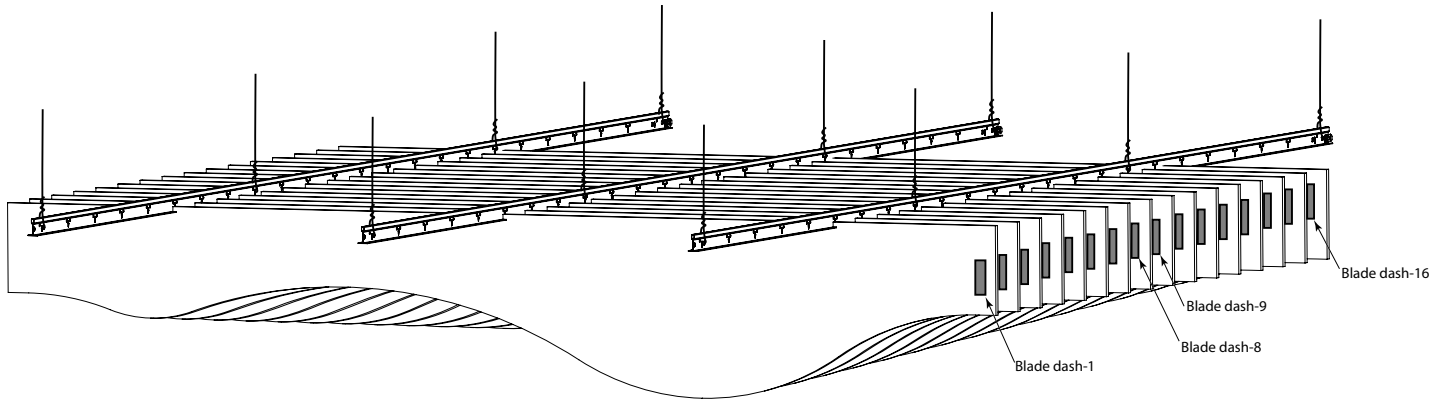

#### REMINDER:

Do not forget to remove all Blade labels upon assembly.

# General Installation

## Static Assembly Installation

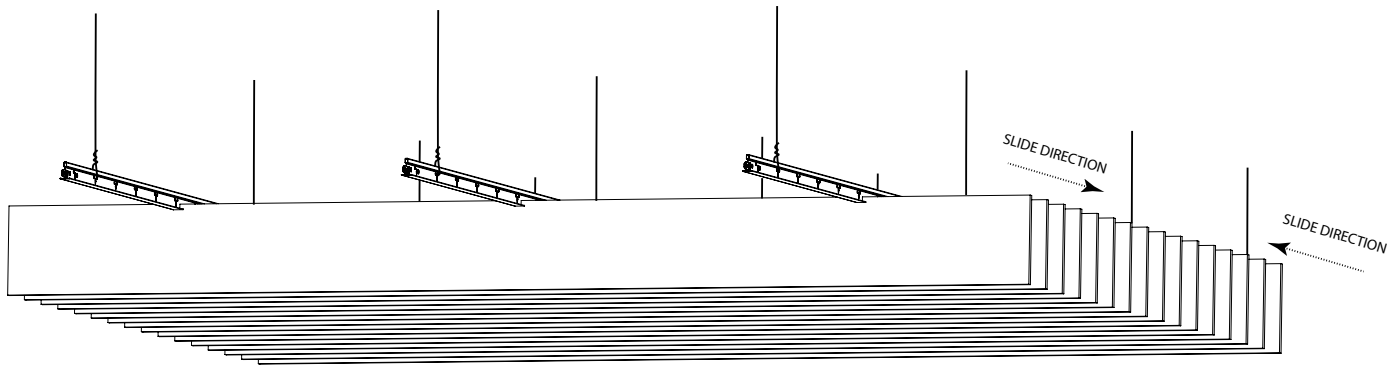

### Suggested installation method for Static Assembly

All Static Assemblies have uniform blade profile, color, and size.

Take half of the blades and install from the front, and take the other half and install from the back.

### BLADES SPACING

Blade spacing for Dynamic or Static assemblies has unlimited adjustment. Once preferred spacing is defined, ensure that the spacing remains consistent between all blades and that the entire assembly is centered along the Main Tees.



Tip:

- Use tape measure to ensure spacing is consistent between all blades.
- The use of a spacer (example: cut 2x4) can ensure the spacing is consistent.
- Measure spacing from each connection on the Main Tee.
- When spacing blades, ensure blade is uniformly straight and not bowing.

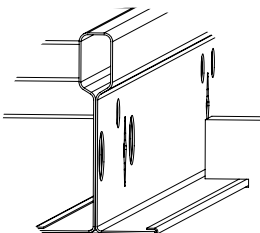

# General Installation

## Blade Spacing

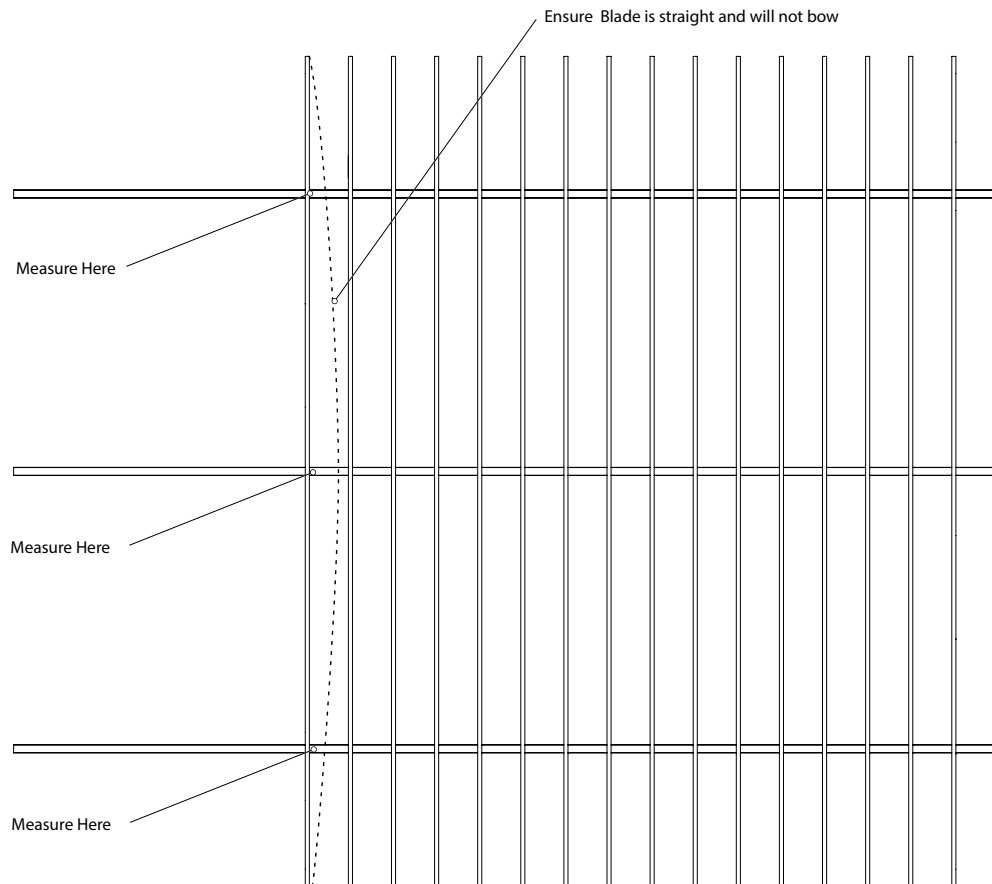
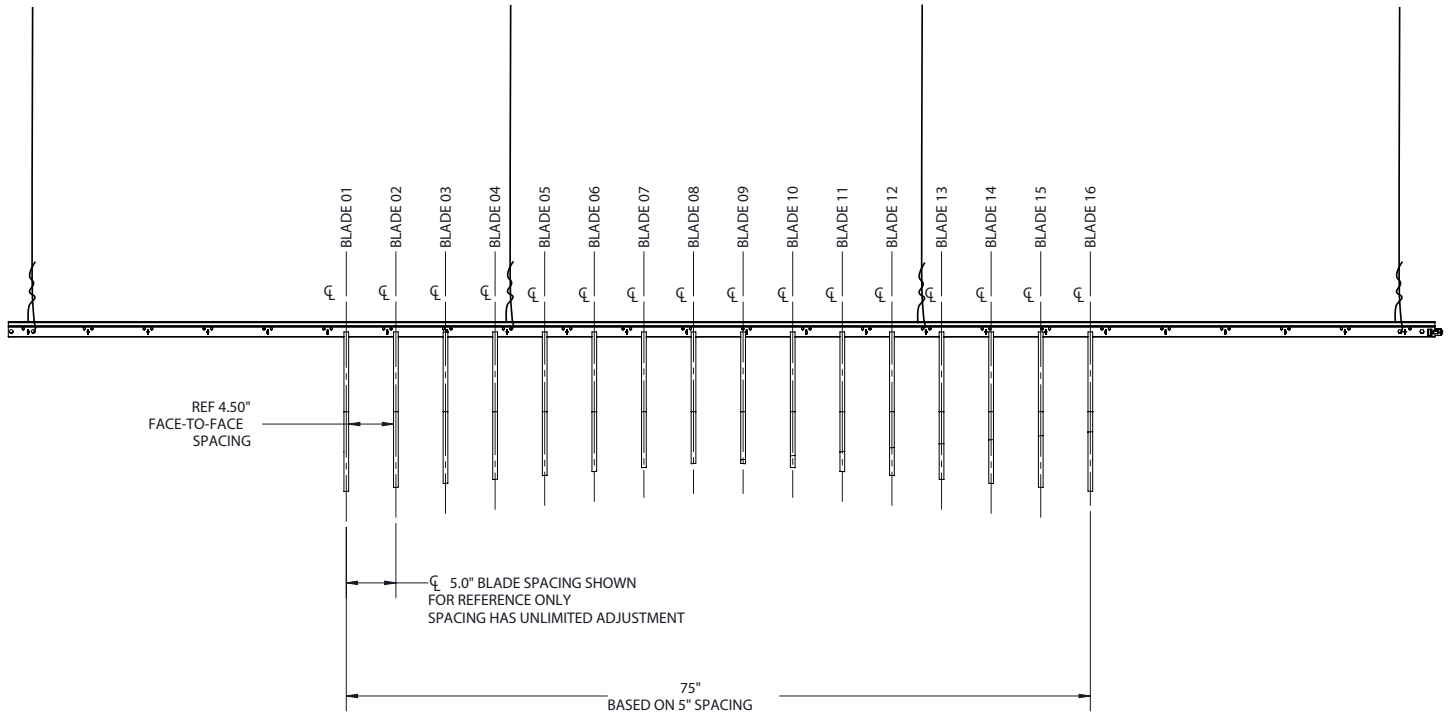

# General Installation

## Multiple bay Assembly

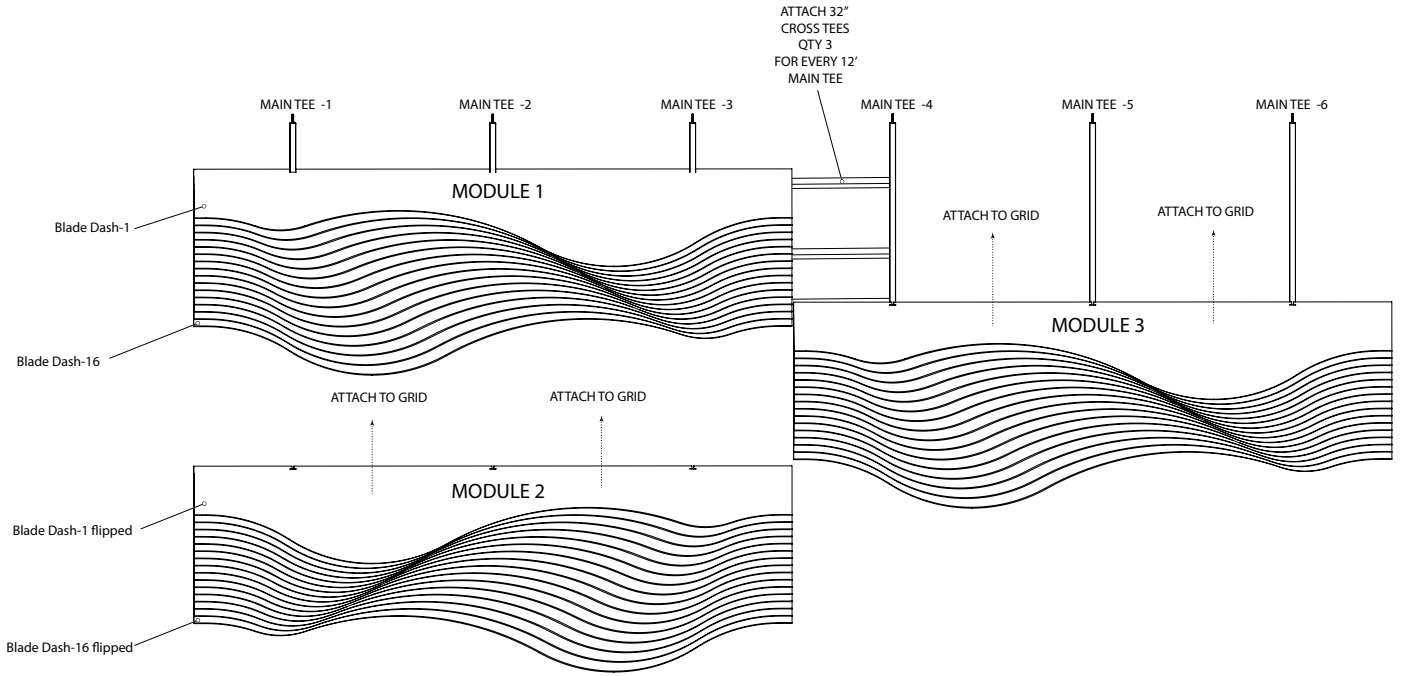

### MULTIPLE MODULE ASSEMBLY

As seen from the figure above, Module 1 is first installed and spaced on the Main Tees. To assemble Module 2 Blades, first flip them so the high and low contours match and gradually continue the aesthetic design intent.

Once Modules 1, 2, 3, and 4 (not shown) are installed on the Main Tees, attach quantity 3, 32" Cross Tees, between the 3rd and 4th Main Tees to strengthen entire assembly. Apply quantity 3, 32" Cross Tees, for every 12' Main Tee. This applies to both Dynamic and Static installations.

Maintain a .25" reveal in between Modules

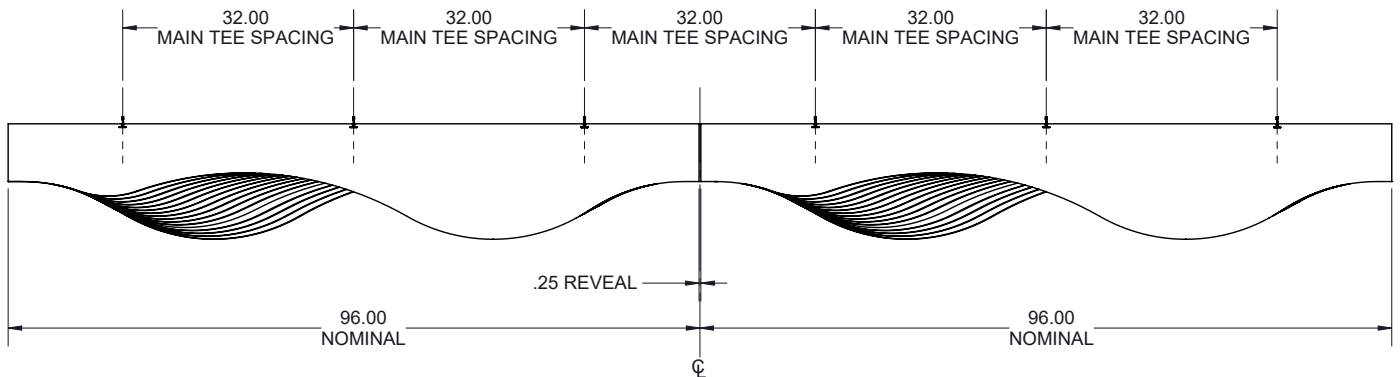

# Field Modification

## Adding a missing dynamic Blade

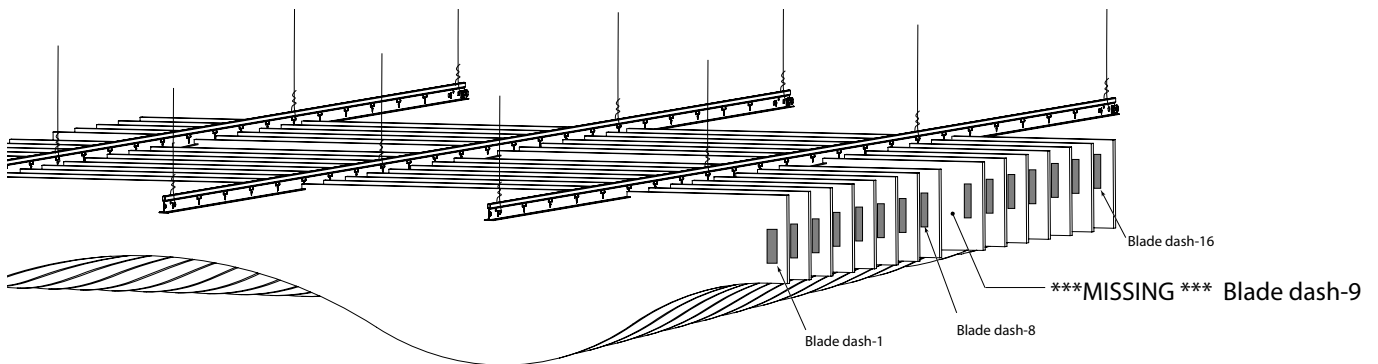

Dynamic Blades must be installed by order of dash number to create the desired effect. At times, a Blade may be out of order or accidentally missed when system was installed.

To remediate such scenarios perform the following:

- 1) First mark the three Main Tees where cuts are to be placed, ensure marks are linear across the three Main Tees.
- 2) Using shears, cut approximately .25" (from outer Main Tee edge) by 1.00" (along the Main Tee face) both sides of the Main Tee, for all three Main Tee's.
- 3) Remove/ reduce any sharp corners to minimize snags with Blades.
- 4) Install dynamic Blade(s).
- 5) Install Tee face cover to cover Main Tee cut and adjust spacing.

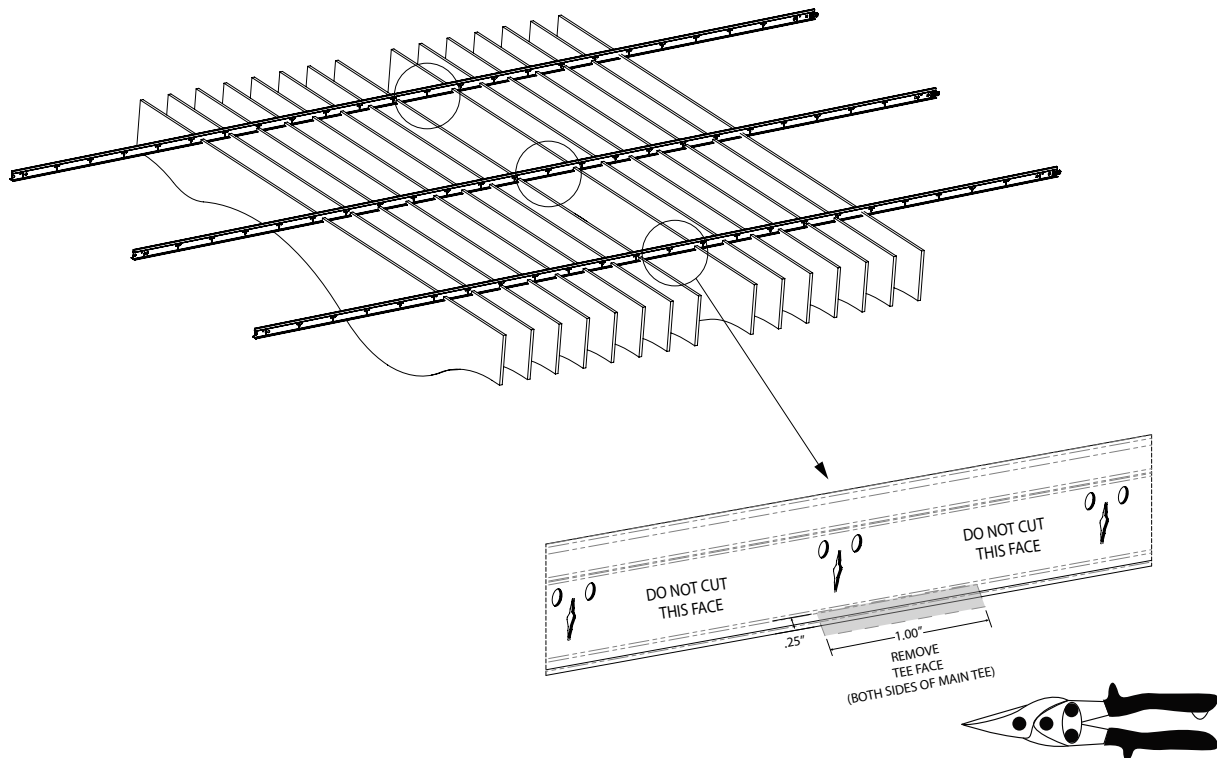



# Field Modification

## Adding Tee Face Sleeve Cover

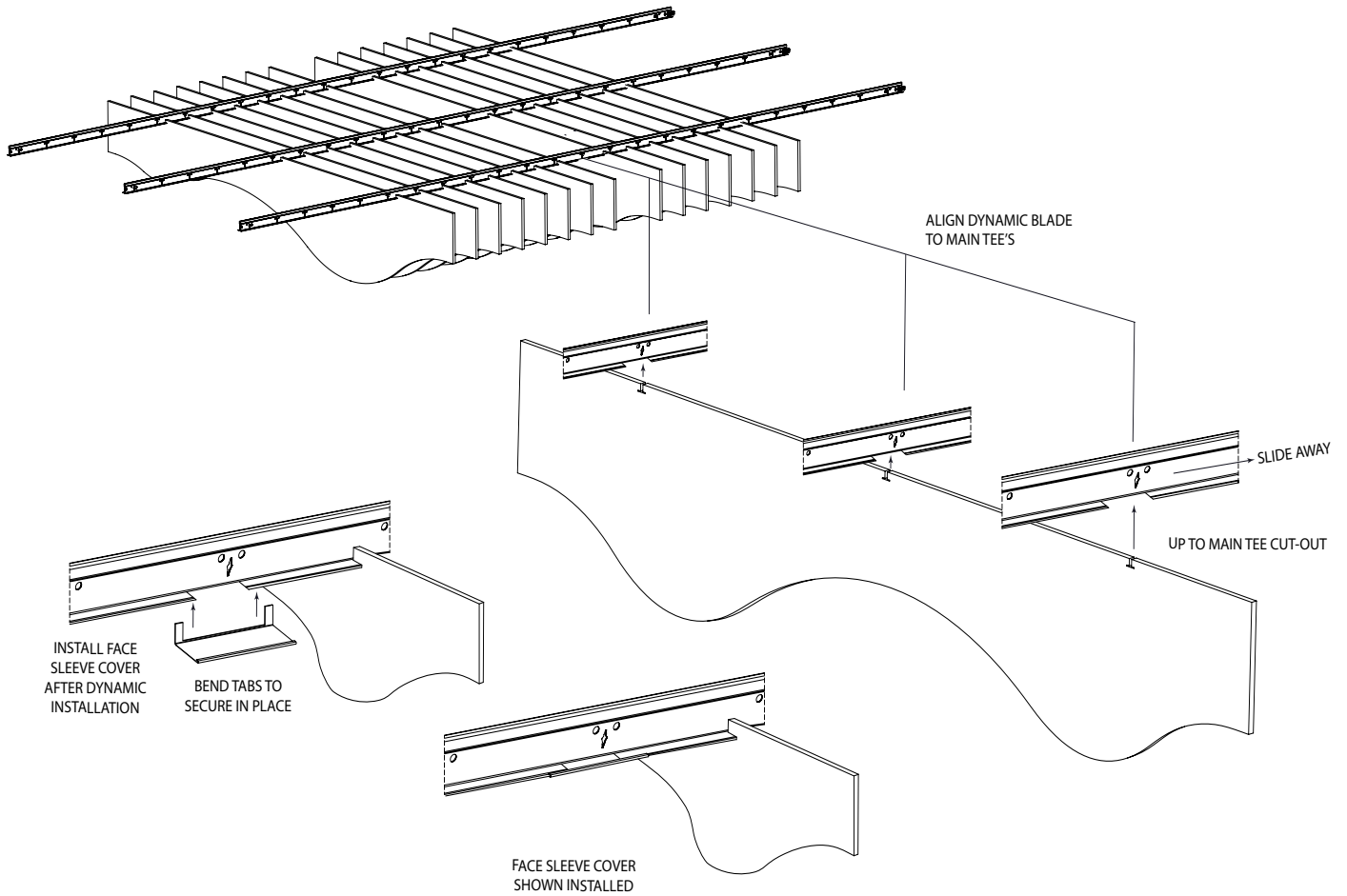

## Maintenance

### Adjust & Clean

- A.** Colortex™ Blades panels are meant for indoor applications only.
- B.** Adjust ceiling components to provide a consistent finish and appearance in conformity with established tolerances and requirements.
- C.** Make sure to have clean hands at all times when handling/touching Colortex™ panels.
- D.** To remove dust, use a vacuum. An angled nozzle end works best.
- E.** If a spill occurs on the material immediately dab area with a clean, damp cloth. Soap and water may also be used if necessary.
- F.** If further cleaning is required, a polyester carpet and fabric cleaner can also be used. Always test on an inconspicuous area first.
- G.** Never expose Colortex™ material to temperatures above 240° F.
- H.** Remove and replace work that cannot be successfully cleaned and repaired to permanently eliminate evidence of damage, including dented and bent units.

---

## Support

### Contacts

**Contact your sales rep for any additional support.**

## Notices

### Safety, Installation, Limitation, Liability

#### SAFETY

Safety First! Follow good safety/industrial hygiene practices during installation. Wear appropriate personal protective equipment. Read SDS and literature before specification and installation. Be cautious with exposed sharp edges when handling ceiling system components.

#### INSTALLATION

Prior to installation, make sure your project complies with any seismic & non-seismic requirements. Must be installed in compliance with ASTM C636, ASTM E580, utilizing standard industry practices and adopting applicable code requirements. Alternative assemblies and installation methods may be utilized when approved by the authority having jurisdiction. USG Ceiling Plus recommends checking with the authority having jurisdiction prior to designing and installing a suspended ceiling system.

#### LIMITATION

Some commercially acceptable color variation may occur between lots and between different size products of the same color.

#### LIABILITY

We shall not be liable for any incidental and consequential damages, directly or indirectly sustained, nor for any loss caused by application of these goods not in accordance with current printed instructions or for other than the intended use. Our liability is expressly limited to replacement of defective goods. Any claim shall be deemed waived unless made in writing to us within thirty (30) days from date it was or reasonably should have been discovered. This product is covered under the standard warranty for USG Ceilings Plus products. For terms and conditions please visit [www.usg.com](http://www.usg.com)

**Notes**  
Planning

---

---

---

---

---

---

---

---

---

---

---

---

---

---

---

---

---

---

---

---

---

---

---

---

---

---